

**Filigrane Teile vorsichtig abtrennen und entgraten!**  
**Überschüssige Teile sind für die Bastelkiste!**

Ersatzteile direkt bei Auhagen GmbH!

Änderungen vorbehalten

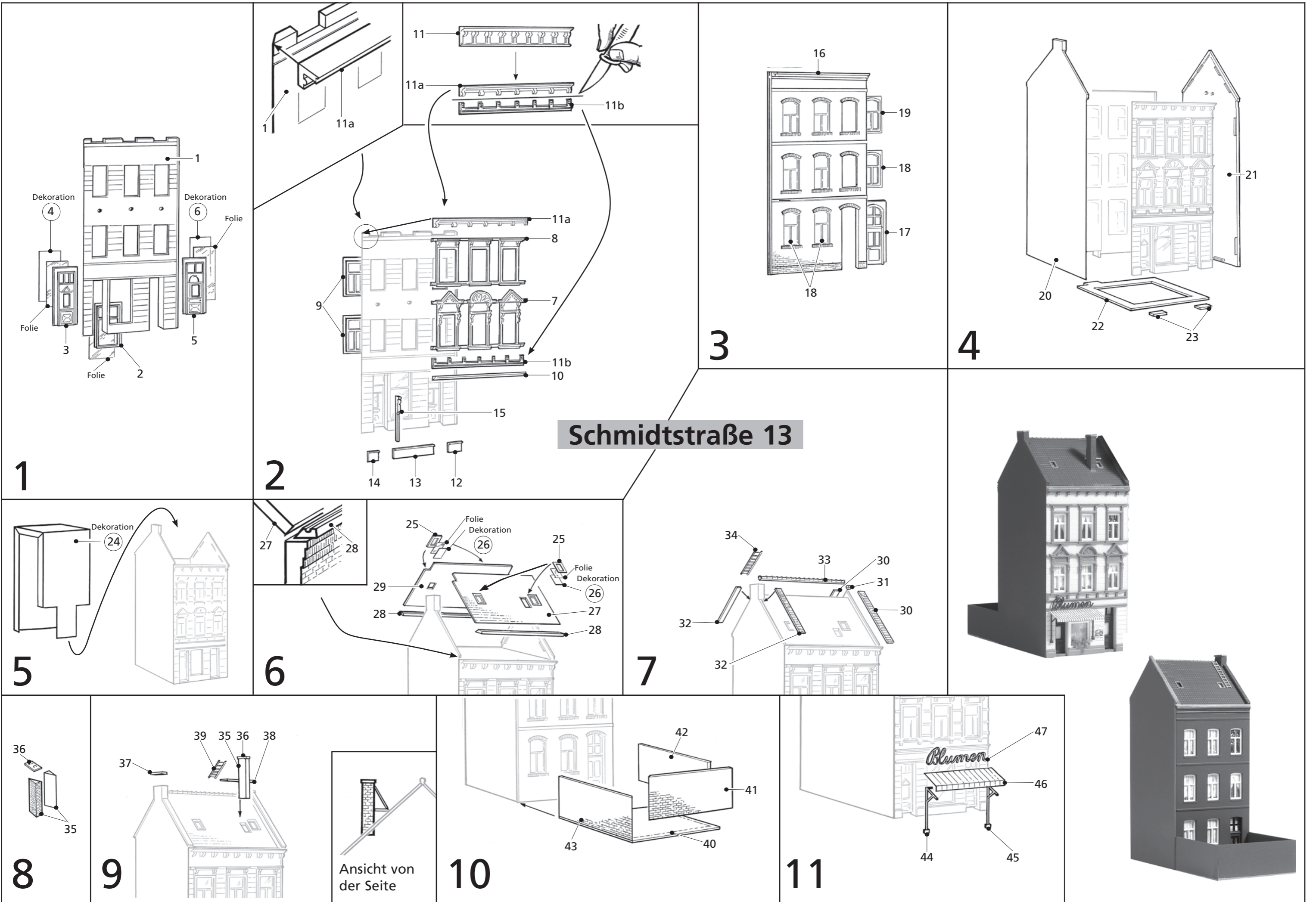

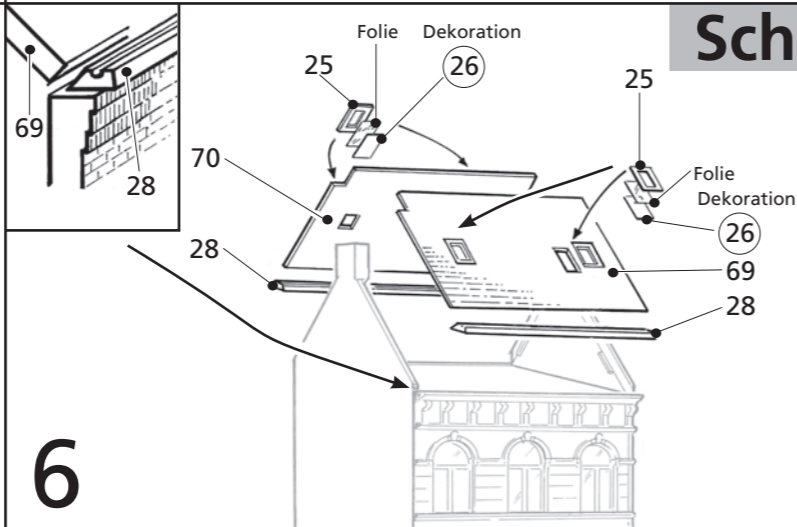
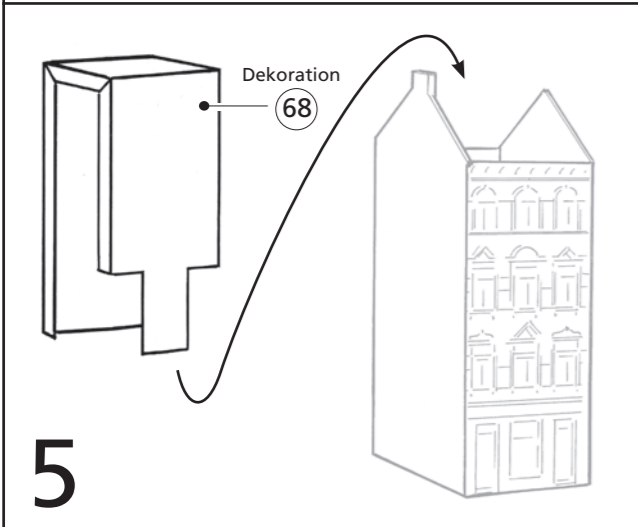
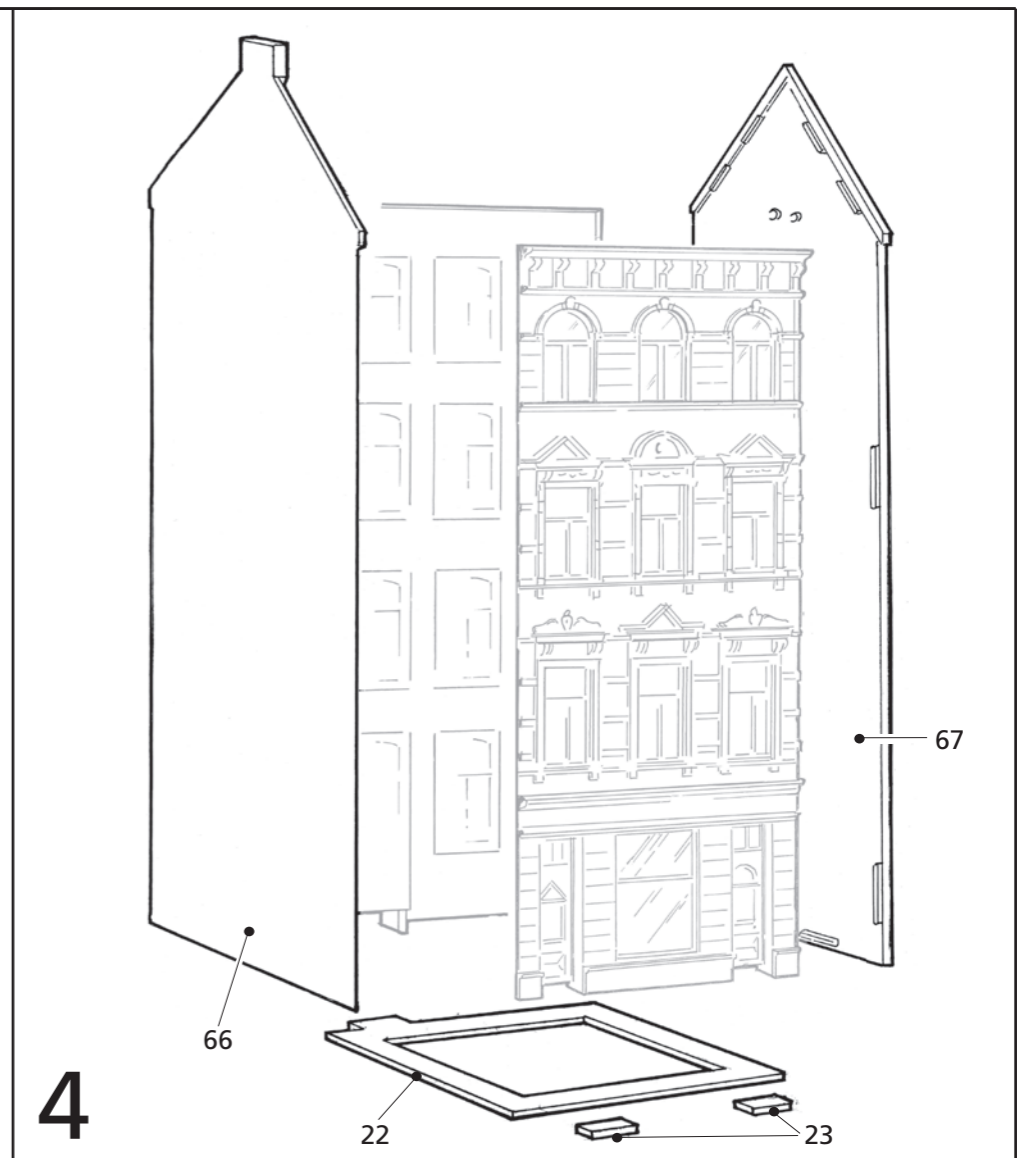
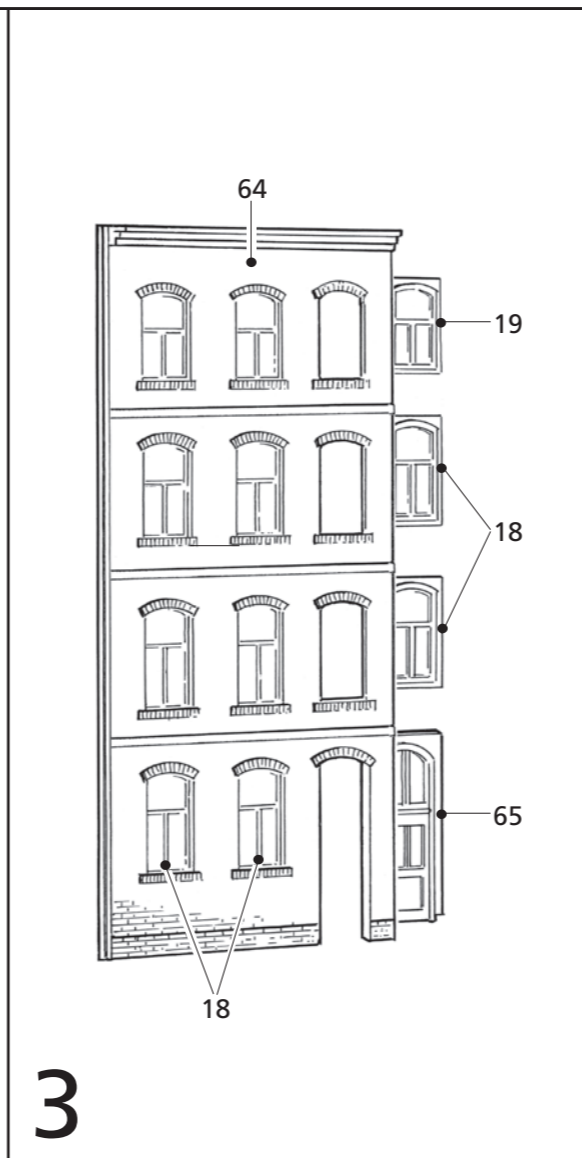
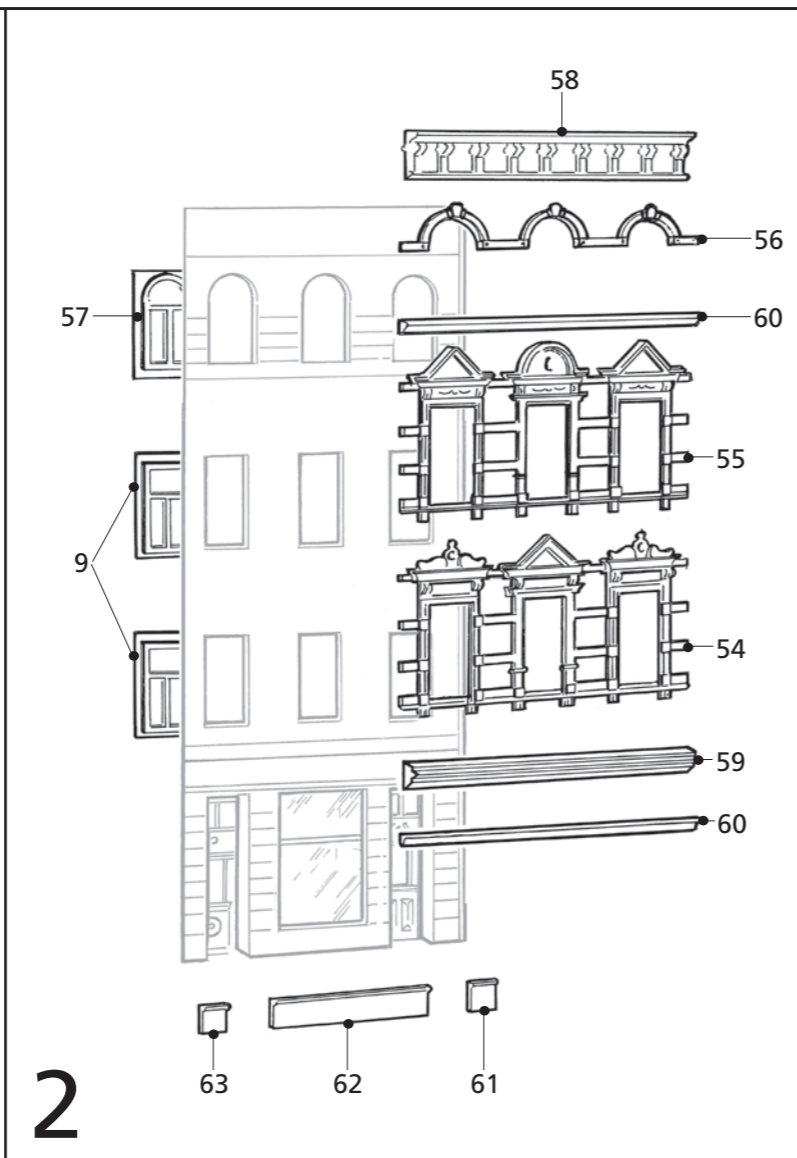
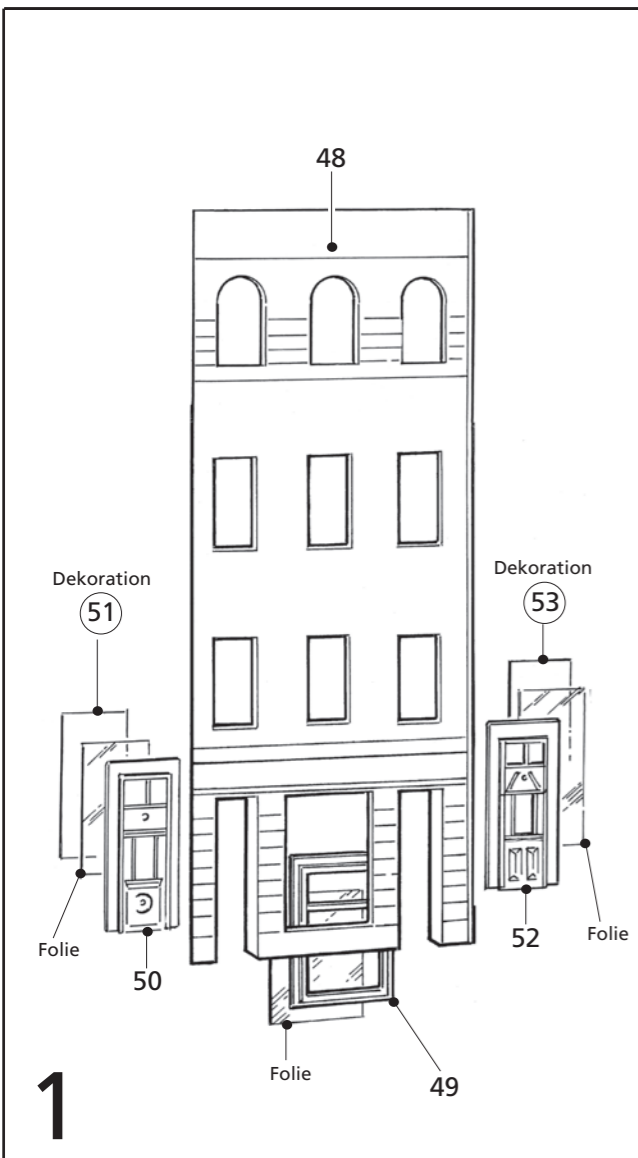

**Schmidtstraße 15**

